

**PROLUNGA
100X100CM
SPESSORE
15CM H50**

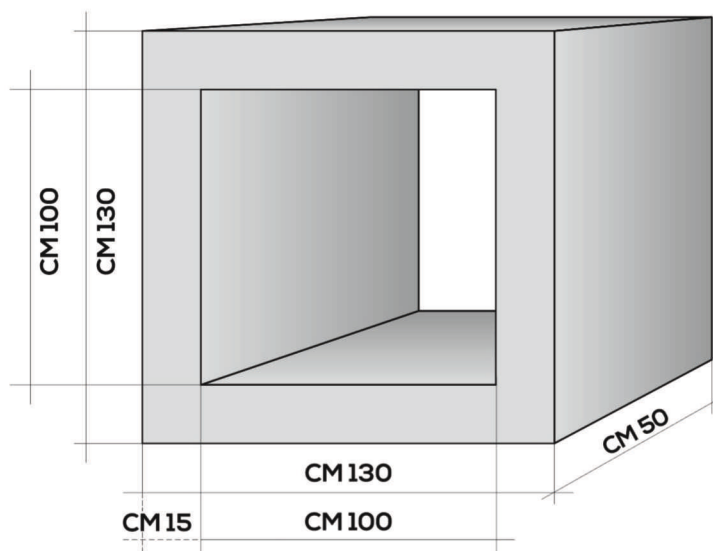
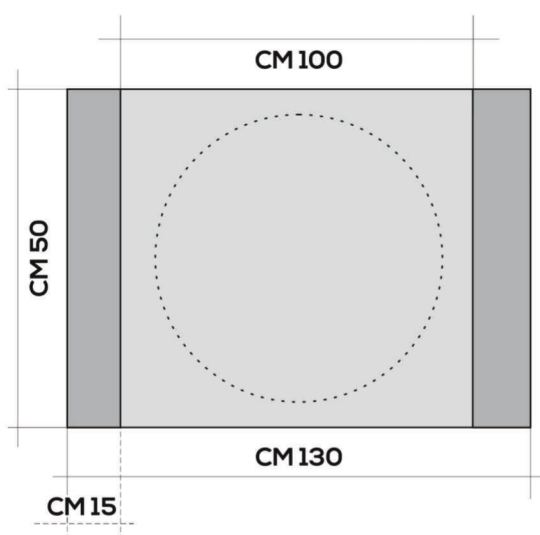

DIMENSIONI E PRINCIPALI CARATTERISTICHE TECNICHE

Dimensioni
Interne
100x100 cm

Dimensioni
Esterne
130x130 cm

Spessore
15 cm

Lunghezza
50 cm

Assorbimento d'acqua per immersione: <15

Colore: grigio cemento

CE