

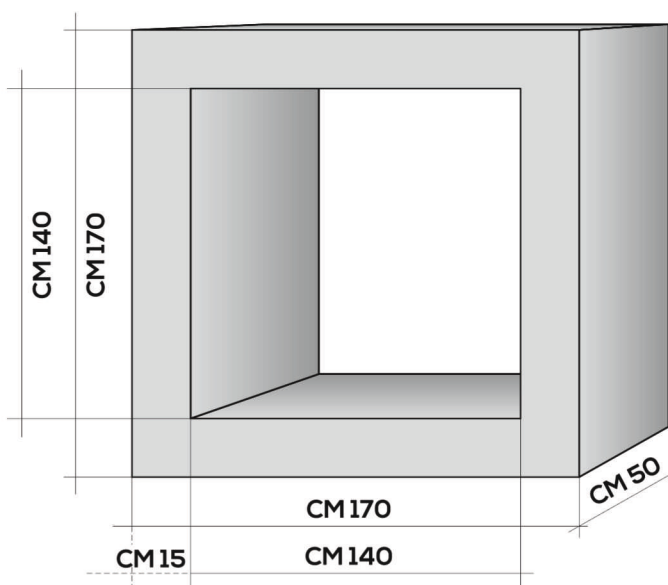

**PROLUNGA
140X140CM
SPESSORE
15CM H50**

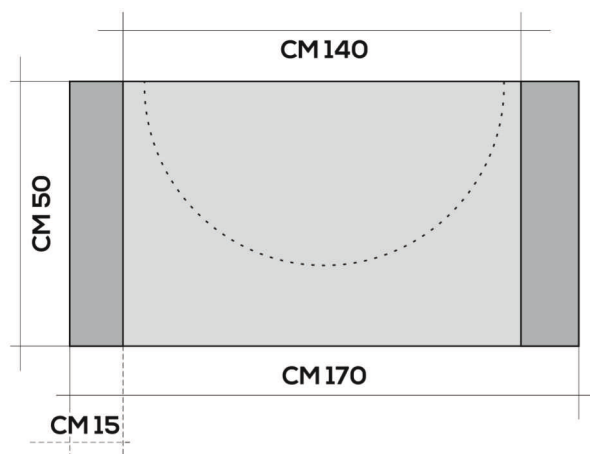

DIMENSIONI E PRINCIPALI CARATTERISTICHE TECNICHE

Dimensioni
Interne
140x140 cm

Dimensioni
Esterne
170x170 cm

Spessore
15 cm

Lunghezza
50 cm

Assorbimento d'acqua per immersione: <15

Colore: grigio cemento

CE